

TOYOTA

Move your world



THIS IS **COROLLA**
A DRIVE
TO BE FREE



EXTERIOR

MORE **PRESTIGIOUS.**

Stand out in the crowd with an imposing new look. With protruding front and rear bumper corners and a front lower grille design that highlights impressive detailing, the Toyota Corolla is ready to take on tomorrow.

Tampil berbeza dengan gaya baharu. Dilengkapi dengan rekaan hadapan melengkung, bampar sisi dan rekaan gril hadapan rendah yang menyerlahkan kemasan terperinci. Toyota Corolla bersedia untuk menawan hari esok.



Auto Bi-LED Headlamps with Follow-Me-Home Function
LED-based that further emphasises the headlamps' wide and dynamic appeal.

Lampu Utama dengan Fungsi Follow-Me-Home

Rekaan estetik Lampu Utama diserlahkan lagi dengan lampu LED.



17" Alloy Rims
Exclusively developed for Prestige models, the alloy rims' multi-axis configuration exudes athletic boldness that adds to its premium profile.

Rim Alooi 17"

Direka khas untuk model Prestige, rim alooi dengan pelbagai paksi yang menampilkan keyakinan, sekaligus menyerlahkan gaya premium.

INTERIOR

MORE **DYNAMIC.**

The interior layout offers full access to all of the Corolla's advanced features. With complete control, the sophistication in every journey will show. Unlock the full mastery of your drive with the Toyota Corolla.

Ruang dalaman yang direka untuk memberi kemudahan akses kepada ciri-ciri kereta, memastikan anda untuk sentiasa menikmati yang terbaik sepanjang perjalanan. Kecapi penguasaan penuh pemanduan dengan Toyota Corolla.



Genuine Leather Seats
Optimised design to help reduce fatigue on long drives by offering enhanced seating comfort and body support.

Tempat Duduk dengan Kombinasi Kulit

Reka bentuk yang diperbaharui mengurangkan kelesuan di saat pemanduan jauh dengan menawarkan sokongan tempat duduk dan badan yang dipertingkatkan.



Instrument Panel
Console finished with glossy black and silver ornaments for a classy feel.

Papan Pemuka dan Konsol Tengah

Rekaan kabin yang lebih elegan dengan kemasan glos hitam dan kelabu pada konsol.



12.3" Full Graphic Meter
Three-dimensional impression of the concave meter cluster cross section with a flat display creates a modern appearance, complete with four visual design options to choose from.

12.3" Meter Grafik Penuh

Meter tiga dimensi dengan kluster cekungan dilengkapi dengan paparan rata menghasilkan penampilan moden, melengkapkan empat pilihan reka bentuk untuk anda.



COMFORT & CONVENIENCE



Dual-zone Auto Air-conditioning

Driver and front passenger are able to set independent temperatures to suit their comfort level.

Penyaman Udara Dua Zon

Pemandu dan penumpang dapat melaras suhu mengikut tahap keselesaan individu.



Automatic Rain-sensing Wipers

Equipped with infrared optical light sensors for millilitre-precision speed adjustment.

Pengelap Cermin Depan dengan Sensor Automatik

Sistem sensor inframerah dengan cahaya optik untuk ketepatan mililiter dan pelarasan kelajuan.



Rear Sunshade

Developed to offer additional shade for rear passengers.

Peneduh Tempat Duduk Belakang

Direka untuk perlindungan tambahan dari cahaya matahari bagi penumpang tempat duduk belakang.



Rear Blower

Conveniently located at centre console box for rear passengers. Specialised ventilation system for optimum humidity.

Penyaman Udara dengan Saluran Tempat Duduk Belakang

Terletak sesuai di konsol tengah bagi penumpang tempat duduk belakang – khusus untuk pengudaraan kelembapan optimum.

PERFORMANCE

Not shy on performance, the Corolla's reinforced exterior gives it an edge in speed and control. Go beyond the rest with the advanced features of a high-performance vehicle designed with prestige in mind.

Prestasi dalam kelas tersendiri. Corolla diperkuat dengan luaran kenderaan yang memberikan kelebihan dalam kawalan dan kelajuan. Dengan ciri-ciri kenderaan berprestasi tinggi yang direka dengan penuh prestij, melangkaui kenderaan lain dalam segmen yang sama.



TNGA Toyota New Global Architecture



TNGA Platform

Optimised weight balance and reinforced vehicular body to provide the visibility, stability, and agility you need for a better driving performance.

Platform TNGA

Keseimbangan berat menyeluruh dan rangka kereta yang diperkuatkan untuk memberi penglihatan, kestabilan dan ketangkasan yang diperlukan untuk prestasi pemanduan yang lebih baik.



Double Wishbone Rear Suspension

Enhanced linear steering response during a mid-to-high speed cornering, giving you superior ride comfort.

Ampaian Tulang Selangka Berganda

Memperkuat gerak balas garisan stereng ketika pembelokan dalam keadaan kelajuan sederhana dan kelajuan tinggi untuk memberi anda keselesaan perjalanan yang hebat.



Drive Mode (ECO & SPORT Mode) with Paddle Shifters

ECO mode maximises fuel efficiency. SPORT mode offers more responsive handling. Paddle Shifters allow for manual mode with up to 7-speed gear shifts.

Mod Pemanduan (ECO & SPORT) dengan "Paddle Shifters"

Mod ECO khas untuk kecekapan bahan api manakala mod SPORT khusus bagi pengendalian responsif. Dalam mod manual, "paddle shifter" membolehkan pemandu menukar penganjak gear hingga 7-kelajuan.



1.8L DOHC Dual VVT-i Engine

Toyota 2ZR-FE known for its balanced power and fuel efficiency. Drive assured with Toyota's quality, durability, and reliability.

Enjin 1.8L DOHC VVT-i Berkembar

Toyota 2ZR-FE dikenali dengan keseimbangan kuasa dan kecekapan bahan api. Pemanduan yang meyakinkan dengan kualiti, ketahanan, dan kebolehpercayaan Toyota.



7-speed Continuously Variable Transmission (CVT)

Automatic transmission retuned for smooth and seamless response during acceleration.

Transmisi Boleh Laras Berterusan 7-kelajuan

Transmisi automatik yang dilaras bagi pengendalian lancar kenderaan dalam kondisi pecutan.

SAFETY

The most premium driving experience comes with the knowledge that you are in full control. That's why the Corolla comes equipped with the extensive technology needed to keep you in command of the road.

Pengalaman pemanduan premium datang dengan pengetahuan anda yang berada dalam kawalan penuh. Oleh itu, Corolla dilengkapi dengan teknologi yang canggih untuk memastikan anda mengawal perjalanan.



Toyota
Safety
Sense

TOYOTA SAFETY SENSE (TSS)



Pre-collision System (PCS)*

Avoids or mitigates frontal collisions by alerting the driver and automatically applying the brakes when there is a risk of collision.

Sistem Pra Pelanggaran*

Dilengkapi dengan sistem amaran kepada pemandu dan juga sistem brek automatik apabila ia mengesan risiko pelanggaran.

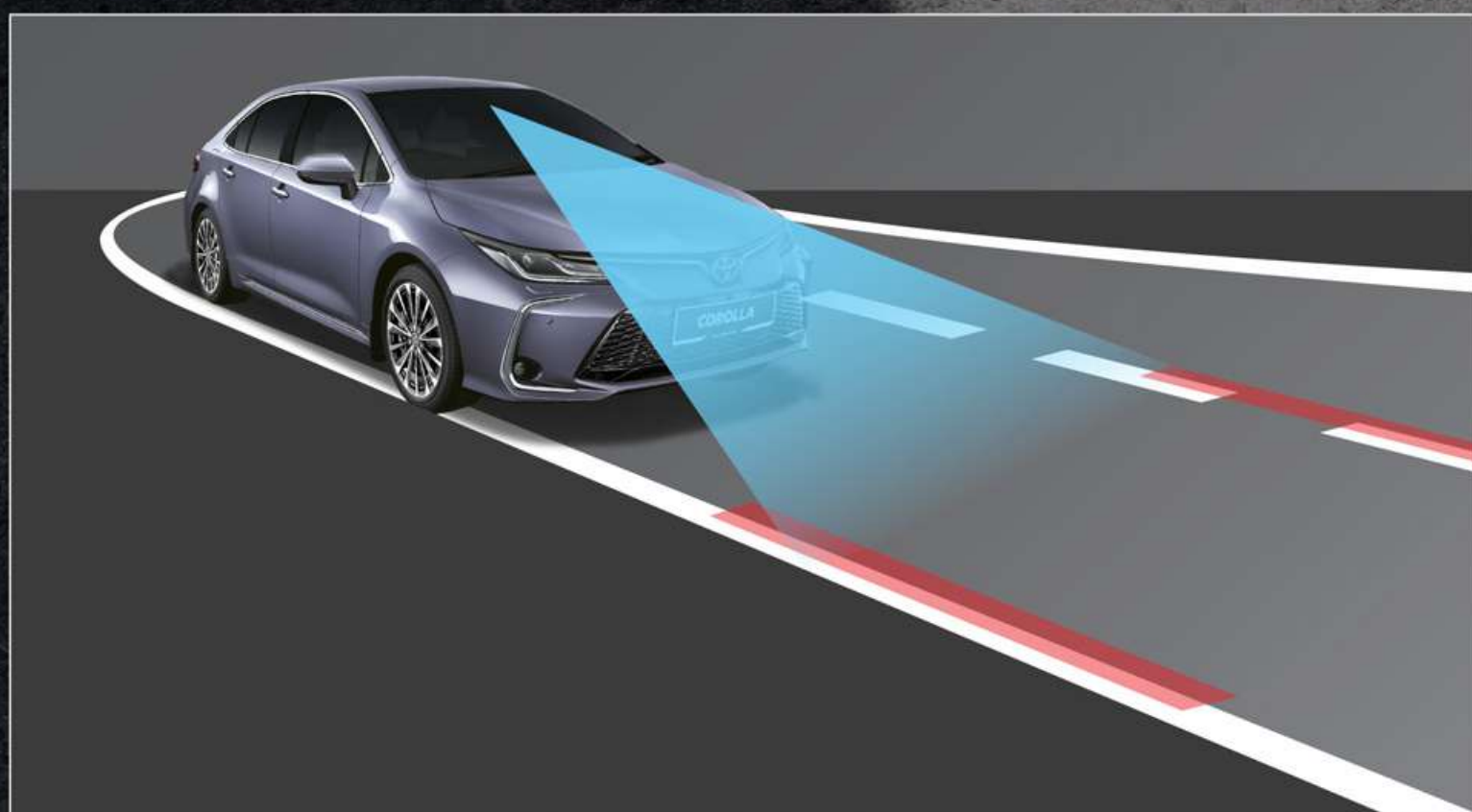

Lane Departure Alert (LDA)*

Alerts and assists when you are out of the lane unintentionally. Less swaying, smoother driving.

Isyarat Amaran Kegunaan Lorong*

Memberi isyarat dan membantu apabila kenderaan terkeluar dari lorong bagi memastikan kelancaran pemanduan.

*Driver remains solely responsible at all times for safe driving.

*Pemandu bertanggungjawab sepenuhnya untuk memastikan keselamatan pemanduan pada setiap masa.
Actual vehicle may vary from image shown.

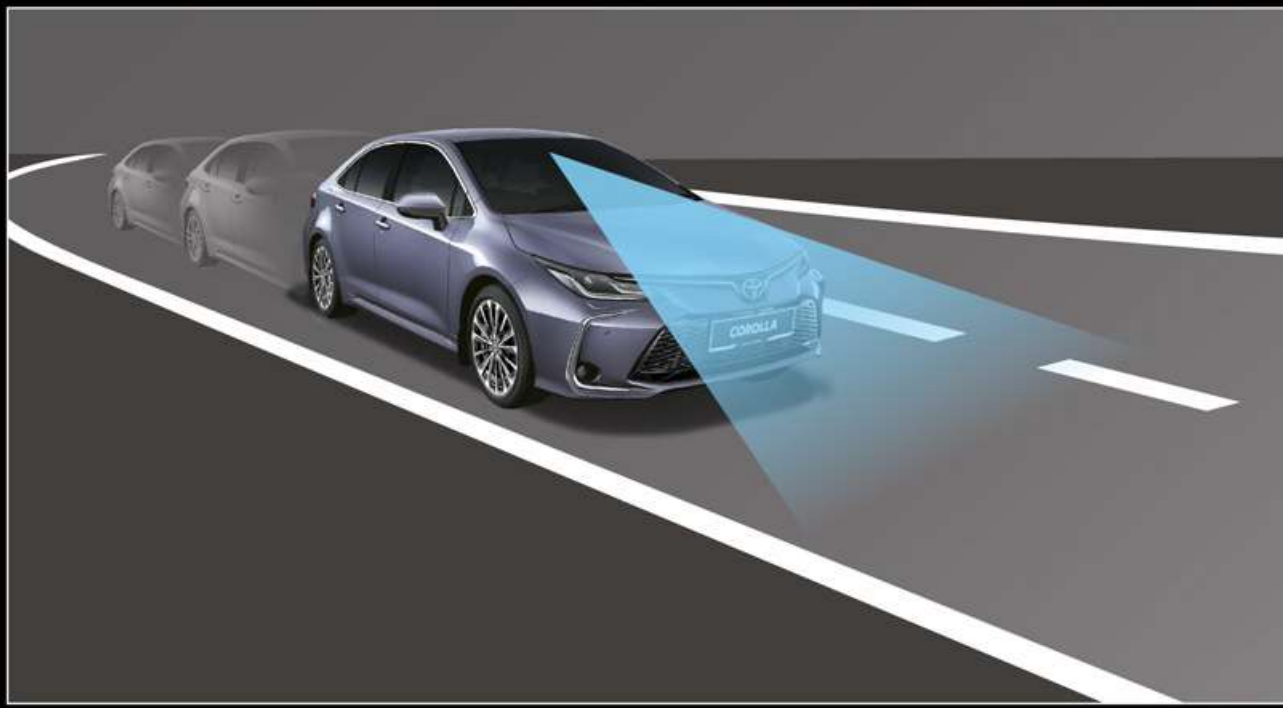

Lane Tracing Assist (LTA)*

Keeps the vehicle centred either by detecting the lane or the preceding vehicle.

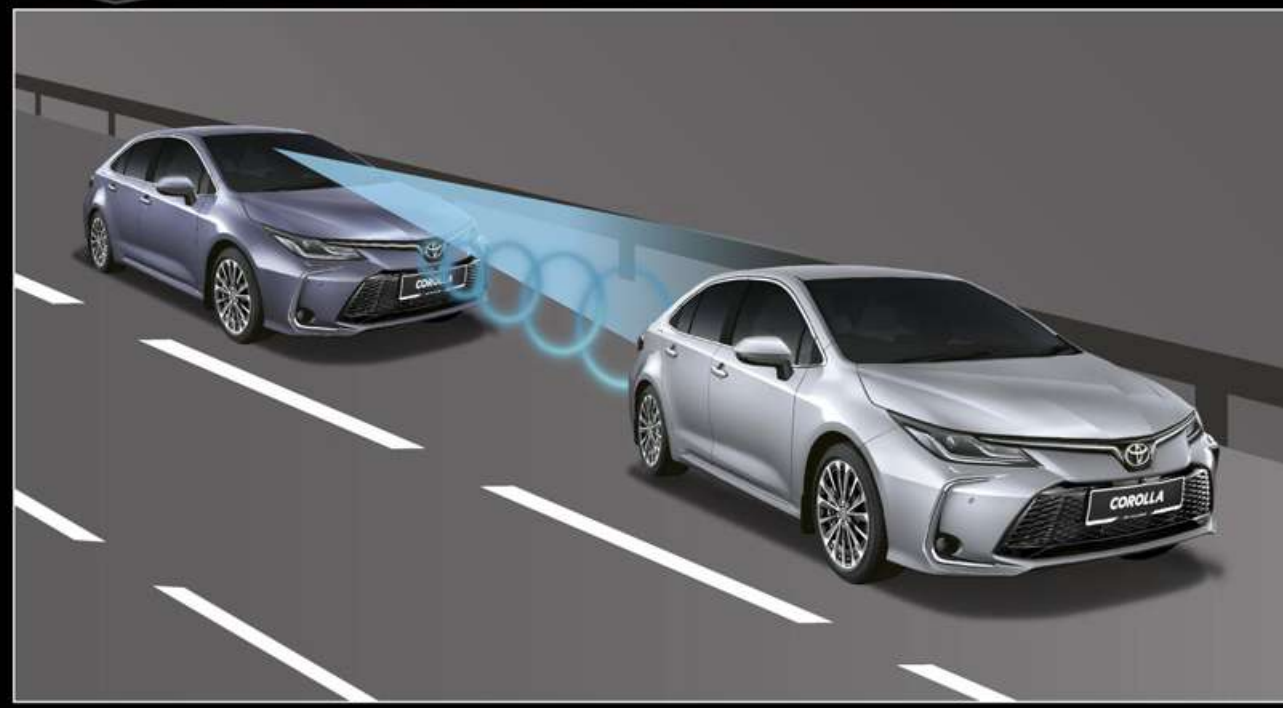

Dynamic Radar Cruise Control (DRCC) for All Speeds*

Maintains a safe distance with preceding vehicle and brakes automatically when the car ahead stops.

Sistem Bantuan Dengan Pengawasan Kawalan Kegunaan Lorong*

Mengekalkan kenderaan di lorong tengah dengan mengesan laluan lorong ataupun kenderaan yang berhampiran.

Radar Dinamik Dengan Kawalan Suai Pandu untuk Semua Had Kelajuan*

Mengekalkan jarak selamat dengan kenderaan hadapan dan brek secara automatik ketika kereta di hadapan berhenti.



Automatic High Beam (AHB)*

Automatically switches between high beam and low beam as needed to provide maximum road visibility.



Rear Cross Traffic Alert (RCTA)*

Using radar sensors to detect approaching traffic, the system alerts the driver through audio alerts and flashing side mirror indicators if a vehicle is detected.

Cahaya Automatik Lampu Besar*

Penukaran automatik antara cahaya lampu besar dan cahaya malam ketika diperlukan untuk memberi penglihatan jalan raya yang maksima.

Amaran Trafik Palang Belakang (RCTA)*

Dengan sensor radar bagi mengesan trafik di persekitaran, sistem ini memberikan amaran kepada pemandu melalui audio dan lampu penanda cermin sisi sekiranya ia mengesan kereta lain.

*Driver remains solely responsible at all times for safe driving.

*Pemandu bertanggungjawab sepenuhnya untuk memastikan keselamatan pemanduan pada setiap masa.



Tyre Pressure Warning System

Notifies you when tyre pressure is below acceptable level, helping you maintain optimum fuel efficiency at all times.

Sistem Pemantauan Tekanan Tayar

Sistem berfungsi untuk memberi notifikasi apabila tekanan tayar di bawah tahap yang sepatutnya dan membantu untuk mengekalkan kecekapan bahan api pada kadar optimum.



Electric Parking Brake (EPB) with Automatic Brake Hold

Keeps the vehicle stationary on flat roads with a simple button. Automatic release during acceleration.

Brek Parkir Elektrik Lengkap dengan Sistem "Brake Hold"

Memastikan kenderaan tidak bergerak sementara anda menukarkan kaki dari pedal brek ke pendikit dengan satu butang. Brek dilepas apabila pedal minyak ditekan.

Emergency Stop Signal (ESS)

In an emergency braking situation, the hazard lamps flash to warn drivers behind.

Isyarat Berhenti Kecemasan (ESS)

Dalam situasi kecemasan, lampu kecemasan akan menyala untuk memberi isyarat kepada pemandu di belakang.

Parking Sensor

Front and rear parking sensors alert the driver when objects are in close proximity resulting in easier parking.

Sensor Parkir

Sensor di hadapan dan belakang memberi amaran kepada pemandu apabila terdapat objek dalam lingkungan sensor.

Actual vehicle may vary from image shown.

360-T Advanced It's all about Trust & Technology by Toyota.

SAFE-T Trust for smoother journeys ahead



Blind Spot Monitor (BSM)
Peninjau Titik Buta (BSM)

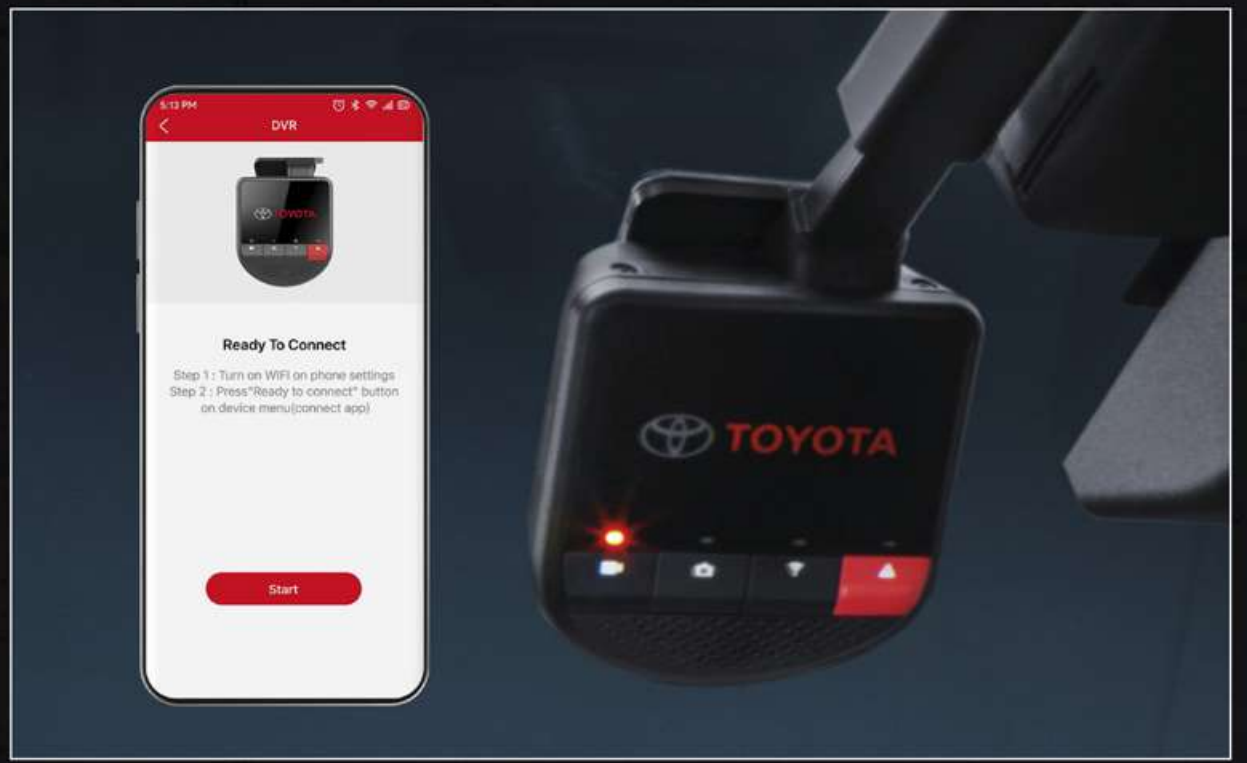

Front & Rear Digital Video Recorder (DVR)
Perakam Video Digital Hadapan & Belakang (DVR)



3D Panoramic View Monitor (PVM)
3D Monitor Pandangan Panoramik (PVM)



7 SRS Airbags
7 Beg Udara SRS

Hill-start Assist Control (HAC)
Kawalan Bantuan Mula-Mendaki

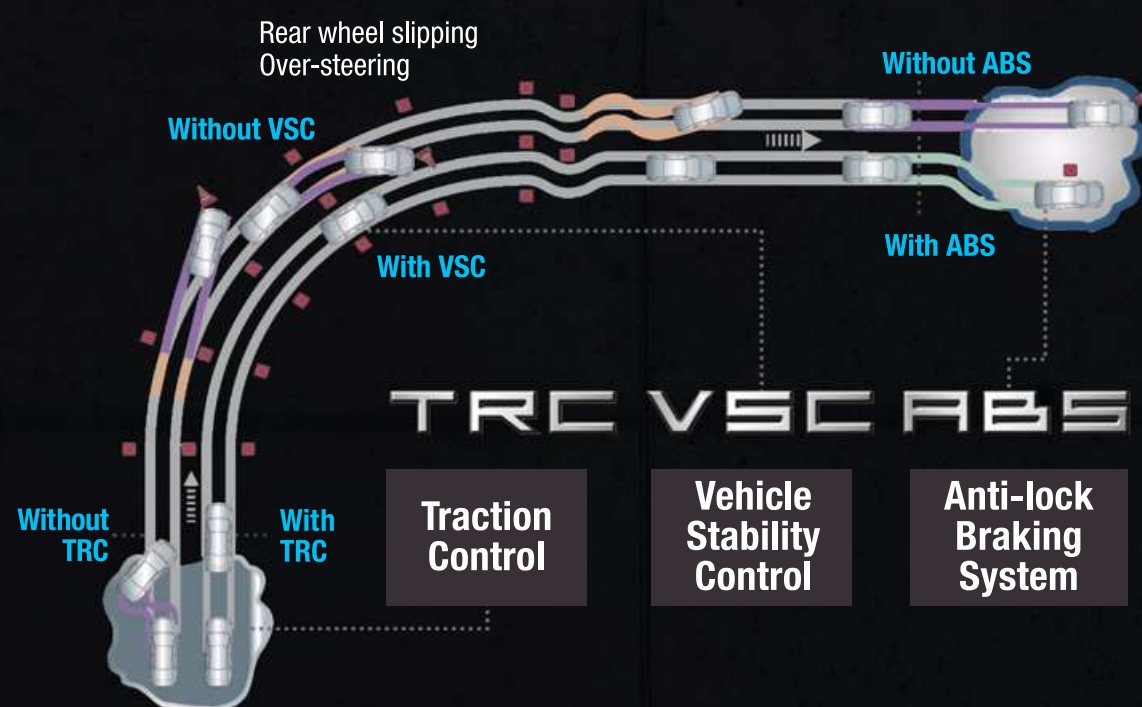
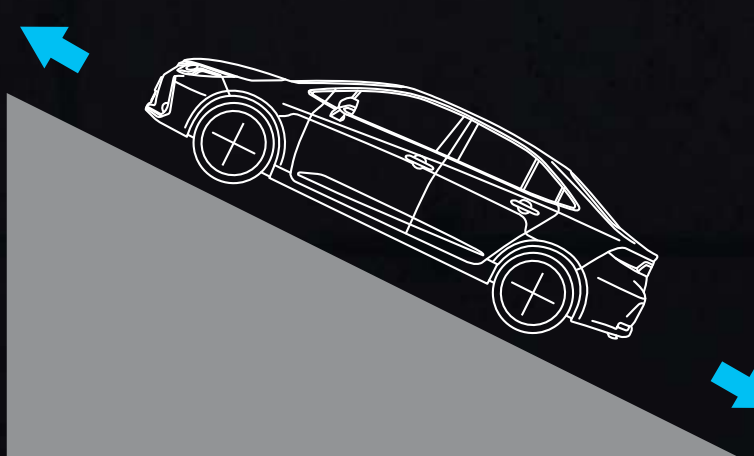

Vehicle Stability Control (VSC) with Traction Control (TRC)
Kawalan Kestabilan Kenderaan (VSC) dengan Sistem Kawalan Cengkaman (TRC)

CONNECTIVI-T Technology at your command

GUARAN-T Total peace of mind



Wireless Charger
Pengecas Tanpa Wayar



10" Display Audio with AACp-ready Connectivity
Paparan Audio 10" dengan Keterkaitan Apple CarPlay dan Android



5 years warranty from the date of first registration with unlimited mileage. Terms and conditions apply.

Waranti 5 tahun daripada tarikh pendaftaran dengan jumlah bantuan tanpa had.

Tertakluk pada terma & syarat.



USB & Accessory Connector
USB & Aksesori Berkuasa



Vehicle Telematics System (VTS)
Sistem Telematik Kenderaan

COLOUR OPTIONS



Celestite Gray Metallic (1K3)



Platinum White Pearl (089)



Metal Stream Metallic (1K0)



Attitude Black (218)



Cement Gray Metallic (1H5)





TOYOTA

Move your world



EXTRA MILE

Toyota prides itself in keeping its cars on the road longer. But beyond its legendary legacy of durability and reliability is the commitment to go the extra mile for every customer. With a comprehensive network of services and facilities across Malaysia to make every Toyota ownership more convenient than ever.

From delivery to your doorstep, holistic car maintenance assistance services, simpler ownership cost management, and much more.

We are more than just an automobile company, we are a mobility company committed to 'Move Your World'.

*A Total of 97 Service Centres Nationwide.
Conveniently located for easy accessibility to quality service and genuine parts.*



Maxcheck

Toyota Quality Service goes the Extra Mile with all the facilities you need to keep your car running at its best.



Insurance Package

Toyota Insurance Package goes the Extra Mile to ensure you're covered, whatever the situation.



Genuine Parts

Toyota Genuine Parts go the Extra Mile for quality, reliability, and higher resale value to bring you peace of mind.



Service Savers

With Toyota Service Savers, we go the Extra Mile so it's easy and more rewarding to keep your new Toyota running at its best.



247 Road Assist

With Toyota 24Seven Road Assist, we go the Extra Mile to keep you safe, back on the road, and moving with Toyota.



Financial Packages

With Toyota Financial Packages, we go the Extra Mile to bring you more financing choices to fit your needs and lifestyle.



Loyal-T

With Loyal-T, we go the Extra Mile to get you more rewarded for enjoying the thrill of the drive with your Toyota.

SPECIFICATIONS

VARIANT		1.8G	
ENGINE			
Model		2ZR-FE	
Type		4-cylinder, In-line, 16-valve DOHC with Dual VVT-i	
Displacement	cc	1,798	
Bore x Stroke	mm	80.5 x 88.3	
Max. Output	kW (PS) / rpm	103 (139) / 6,400	
Max. Torque	Nm (Kg-m) / rpm	172 (17.6) / 4,000	
TRANSMISSION			
Type		7-speed Sequential Shiftmatic CVT	
Paddle Shifters		With	
CHASSIS			
Suspension	Front / Rear	MacPherson Strut with Stabiliser / Double Wishbone with Stabiliser	
Brakes	Front / Rear	Ventilated Disc / Solid Disc	
Tyres & Rims		225/45 R17, Alloy	
Spare Tyre & Rim		225/45 R17, Alloy	
Steering		Electric Power Steering	
DIMENSIONS			
Overall	Length	mm	4,630
	Width	mm	1,780
	Height	mm	1,435
Wheelbase	mm	2,700	
Kerb Weight	kg	1,365	
Fuel Tank Capacity	litre	50	
Minimum Turning Radius	m	5.4	
EXTERIOR			
Headlamps	Type	Automatic Bi-LED Projector with LED Turn Signals	
	Levelling	Manual	
	Daytime Running Lights	With (LED)	
Rear Combination Lamps		LED Tail and Stop Lamps	
Fog Lamps		Front and Rear	
Acoustic Windshield Glass		With	
Radiator Grille		Glossy Black + Plating	
Front & Rear Bumpers		With	
Door Lower Moulding		With	
Wing Mirrors		Power-adjustable, Auto Fold and Signal Lamps	
Remote Trunk Release		With	
Wipers		Automatic with Rain Sensor	
Door Visor		With	
Antenna		Glass Printed	
INTERIOR			
Smart Entry and Start System		With	
Drive Mode		With (ECO & SPORT Mode)	
Meter Combination		Full LCD Meter	
Multi-information Display (MID)		12.3" Colour TFT	
Air-conditioning		Dual-zone, Automatic Climate Control with Rear Vents	
Steering Wheel	Type	3-spoke Leather with Tilt & Telescopic Adjustable	
	Switches	Audio, MID, Telephone, Dynamic Cruise Control & Lane Tracing Assist	
Gear Shift Lever		Leather	
Power Windows		Front and Rear with Auto Up/Down & Jam Protection (All Windows)	
Audio	Type	Display Audio with 10" Capacitive Touch Screen, Apple CarPlay & Android Auto-ready Connectivity, Miracast, USB & Bluetooth®	
	Speakers	6	
Interior Colour & Trim		Black	

DIMENSIONS

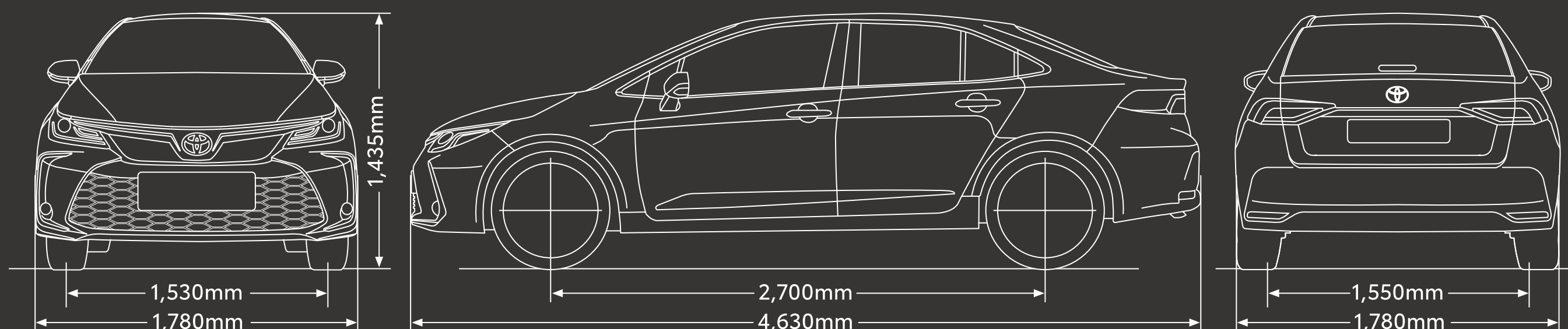

SPECIFICATIONS

VARIANT	1.8G	
INTERIOR		
	Material / Colour	Leather with Double Stitching / Black
Seats	Driver Seat	Powered 8-way Adjustable with Power Lumbar Support
	Front Passenger Seat	Manual Adjust
	Rear Seat	60:40 Split Foldable
	Rear Armrest	With Cupholders
	Inside Rear View Mirror	Electrochromic Mirror
Sun Shade		With
USB Charging Ports		With
Wireless Charger		With
Illuminated Entry System		With (Push Start & Room)
3D Panoramic View Monitor (PVM)		With
Digital Video Recorder (DVR 3.0+)	Front	With
	Rear	With
Portable Tyre Pump		With
Luggage Tray		With
SAFETY		
ACTIVE		
Toyota Safety Sense		
	Pre-collision System (PCS)	With
	Lane Departure Alert (LDA) with Steering Assist & Lane Tracing Assist (LTA)	With
	Dynamic Radar Cruise Control (DRCC) All Speed	With (All Speeds)
	Automatic High Beam (AHB)	With
	Blind Spot Monitor (BSM)	With
	Rear Cross Traffic Alert (RCTA)	With
	Vehicle Stability Control (VSC) & Traction Control (TRC)	With
	Anti-lock Braking System (ABS)	With Electronic Brake-force Distribution (EBD) and Brake Assist (BA)
	Hill-start Assist Control (HAC)	With
	Emergency Stop Signal (ESS)	With
	Parking Sensors	With (Front & Rear)
	Parking Brake	Electric Parking Brake (EPB) with Automatic Brake Hold
	Tyre Pressure Warning System	With
PASSIVE		
	SRS Airbags	7 Airbags (Front, Front Side, Curtain & Driver Knee)
Seatbelts	Warning	Driver, Front Passenger & Rear Passenger
	Front	3-Point ELR x 2 with Pretensioner and Force Limiter
	Rear	3-Point ELR x 3
	ISOFIX	With (Rear Only)
SECURITY		
	Alarm System	Remote Control Units, Immobiliser, Siren with Backup Battery, Cabin Sensor & Speed Auto Door Lock
	Toyota Premium Security & Solar Film	With
	Vehicle Telematics System (VTS)	With

- UMW Toyota Motor reserves the right to alter any details of specifications and equipment without notice.
- Details of specifications and equipment are also subject to change to suit local conditions and requirements.
- Vehicle and specifications in this catalogue may vary from models available locally.
- Vehicle body and accessory colours might differ from the printed photos in this catalogue.
- All images used are for illustrative purposes.



5 years warranty from the date of first registration with unlimited mileage. Terms and Conditions apply.

— | Follow us! | —

